

**Product:** KLUDI drench shower DN 15

**Ref.:** 6051005-00

**Product description**

drench shower DN 15  
 wall fastening  
 flow class D  
 heavy die-casted model  
 with ball joint and escutcheon Ø 58 mm  
 noise group I

Finishes:  
 05 chrome

**Product picture**



**Advertisement**

- \* KLUDI GmbH & Co KG KLUDI drench shower item no. 6051005-00
- \*\* chrome plated brass, DIN 50930-6 / DIN EN 248
- \*\*\* DIN EN 200

drench shower, manufacturer KLUDI GmbH & Co KG KLUDI drench shower item no. 6051005-00, DN 15, chrome plated, heavy die-casted model, with ball joint and escutcheon, free-outlet, connection 1/2 inch, breadth 90 mm, projection 130 mm, with wall-rosette Ø 58 mm, noise level DIN 4109 group II, without report no., flow rate (free flow) at 3 bar ~ 37,0 l/min, PN 5,

**Dimensional drawing**

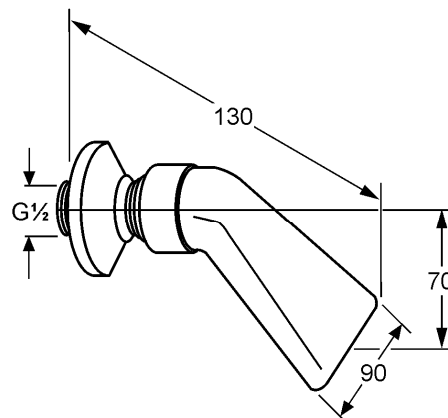

**Flow rate diagram**

